

SINGER
110W126,W127

LIST OF PARTS



MACHINES

Nos. 110w126 and 110w127

THE SINGER MANUFACTURING COMPANY

Instructions for Ordering

In ordering from this list, use **ONLY** the **PART** number in the **FIRST** column.

The number stamped on a Sewing Machine Part is the number of the Single Part only, except when the part includes Set Screws, Clamping Screws, Studs and Rollers Spun on, Small Wires riveted, or Parts soldered together, etc., which it is necessary to furnish in combination.

Every combination of parts sent out has its specific number which, although not stamped on Parts (except in above cases) must be used when ordering the combination.

Each number always indicates the **SAME PART** in whatever list it appears, or for whatever Machine.

The letters after some of the numbers indicate the style or finish only, as follows:

- A. Hardened, Polished and Plated.
- B. Polished and Plated.
- C. Hardened only.
- D. Polished only.
- E. Soft, not polished.
- F. Hardened and Polished.
- H. Blued.

These letters **MUST BE USED** when they appear in the list and **AFTER** the number, as in the list.

In this series

200001 to 201500 are Screw Numbers.

201501 to 201800 are Nut Numbers.

201801 to 202000 are Roller Numbers.

202001 and upwards are Numbers of Machine Parts.

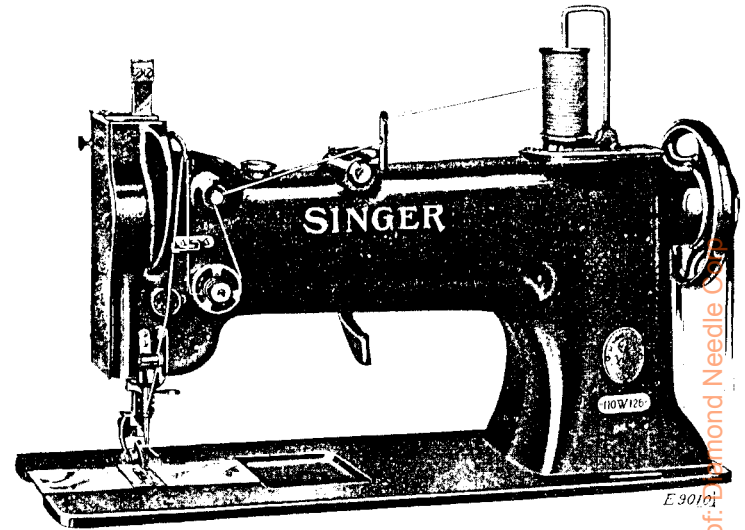
The figures in the second column refer only to the plate in which the illustration of the part is shown and are **NOT TO BE USED** in ordering.

Two or more numbers over a cut indicate that the difference between such parts is not visible in an illustration.

Parts marked with an asterisk (*) are furnished only when repairs are made at the factory.

LIST OF PARTS COMPLETE

FOR



MACHINE No. 110w126

VERTICAL HOOK. ROLLER PRESSER.

CONTINUOUS WHEEL FEED.

VERTICAL TRIMMER

For Leather Work

No.	Plate	Name
*237801	---	Arm
203091	14196	" Cap
200278n	14176	" " Screw
202248	14176	" " " Washer
203089	14196	" " Spool Holder Base
203090	14196	" " " " " 203089 with 200079n and 204296
200585n	14187	Arm Cap Spool Holder Base Screw
204296	14196	" " " " Wire
200079n	14187	" " " " " Hinge Screw

No.	Plate	Name
203092	—	Arm Cap and Spool Holder complete, Nos. 203090, 203091 and two 200585H
204235	14187	Arm Position Pin (2)
200004E	14176	" Screw
200010E	14176	" " (2)
202005	14176	" " Washer (3)
202632	14196	" Side Plate
200462B	14176	" " " Thumb Screw
237802	14414	" Shaft with 200357E and 203100
237748	14196	" " Bushing (back) with 202299
202299	—	Arm Shaft Bushing (back) Oil Packing (wick)
200071E	14176	Arm Shaft Bushing (back) Screw (3)
207080	14196	Arm Shaft Bushing (front) with 202244
202244	—	Arm Shaft Bushing (front) Oil Packing (wick)
200502B	14176	Arm Shaft Bushing (front) Oil Packing Thumb Screw
200338C	14176	Arm Shaft Bushing (front) Set Screw
203100	—	Arm Shaft Oil Packing (wick)
200357E	14176	" " " " Stop Screw
223842	14414	Balance Wheel (belt groove 23 in. diam.) with 200328c and 200335c
200062H	14176	Balance Wheel Adjusting Screw
200328c	14176	" " Position Screw
200335c	14176	" " Set Screw
*237834	—	Bed
237901	14196	" Slide (back)
237835	14196	" " (front)
203470	14176	Bobbin
*203520	—	" Case
203648	14176	" " Latch
*202056	—	" " " Pin
203473	14176	" " " Plunger
203474	14176	" " " Spring
236078	14176	" " Lever
*203476	—	" " " Eccentric
204243	14176	" " " Position Pin
235751	14176	" " " Fulcrum
200056D	10884	" " " Screw
203478	14176	" " " Slide Stud
203214	14176	" " Tension Spring
200984c	14176	" " " " Regulating Screw

No.	Plate	Name
200594c	14176	Bobbin Case Tension Spring Screw
203216	—	" " Washer (cloth)
203521	14176	Bobbin Case complete, Nos. 200594c, 200984c, 202056, 203214, 203216, 203473, 203474, 203520 and 203648
237804	14414	Face Plate
202135	14176	" " Position Pin
200473B	14176	" " Thumb Screw
237707	14190	Feed Wheel
350085F	14398	" " Adjusting Screw
237708	14398	" " " " Block
238603	14410	" " Bracket with 238630
238604	14410	" " " Plate
200158H	14398	" " " " Screw (2)
237710	14398	" " " Spring
238605	—	" " Driving Gear (for 16 stitches)
238606	—	Feed Wheel Driving Gear (for 18 stitches)
238607	—	Feed Wheel Driving Gear (for 20 stitches)
238613	14398	Feed Wheel Driving Gear Key
238614	14398	" " " " " Shift-ing Collar with 201464c
201464c	14187	Feed Wheel Driving Gear Key Shift-ing Screw Stud
238615	14398	Feed Wheel Driving Gear Key Spring
201202D	14398	Feed Wheel Driving Gear Key Spring Screw
238616	14398	Feed Wheel Driving Gear Key Stop Pin
238617	14398	Feed Wheel Driving Gear Separating Washer
238618	—	Feed Wheel Driving Pinion (for 16 stitches)
238619	—	Feed Wheel Driving Pinion (for 18 stitches)
238620	—	Feed Wheel Driving Pinion (for 20 stitches)
231433	14398	Feed Wheel Driving Pinion Key
238632	14403	" " " " Spacing Washer (for use in place of Feed Wheel Driving Pinion when one or two lengths of stitch are required)
238627	14414	Feed Wheel Driving Shaft
237722	14410	" " " " Bushing (back)

No.	Plate	Name
202302	14399	Knee Lifter Connection Lever Lifting Rod Cotter Pin
237838	14414	Knee Lifter Lifting Lever
200262H	14399	" " " " Hinge Screw
207805	14187	Knife
200397H	11610	" Adjusting Screw
237806	14190	" Bar
237807	14187	" " Angle Extension
200126E	14187	" " " " Screw (2)
221417	14190	" " Driving Eccentric with 200382c and 200437c
202890	14190	Knife Bar Driving Eccentric Fork with 200382c and 201464c
201464c	14187	Knife Bar Driving Eccentric Fork Position Screw
200382c	14198	Knife Bar Driving Eccentric Fork Set Screw
200437c	14187	Knife Bar Driving Eccentric Position Screw
200382c	14198	Knife Bar Driving Eccentric Set Screw
202891	14192	Knife Bar Driving Shaft Crank with 200694F and 201525E
203244	14187	Knife Bar Driving Shaft Crank Collar with two 200393c
200393c	14187	Knife Bar Driving Shaft Crank Collar Set Screw
200694F	14187	Knife Bar Driving Shaft Crank Screw Stud
201525E	14187	Knife Bar Driving Shaft Crank Screw Stud Nut
237808	14187	Knife Bar Guide Block
200011D	14187	" " " " Screw (2) ..
200337c	14187	" " " " Screw
201531E	14187	" " " " Nut
237829	14187	" " Lifting Spring
202346	14187	" " " " Plunger ..
237809	14198	" " Position Bracket
201387F	14198	" " " " Screw (2) ..
237810	14198	" Holder with 200397H
200898D	14198	" " Screw
237811	14198	" " Switch-in Handle
200076D	14198	" Screw (2)
237812	14192	" Switch-out Handle with two 200403c
200403c	14415	Knife Switch-out Handle Set Screw
202899	14192	" " " Shaft
202900	14198	" " " Spring (spiral)

No.	Plate	Name
237822	14192	Needle Bar with 200389c
202552	11607	" " Connecting Link
236073	14399	" " " " Oil Guard
200161D	11607	Needle Bar Connecting Link Oil Guard Screw
202333	11607	Needle Bar Connecting Link Stud with 202254
202254	---	Needle Bar Connecting Link Stud Oil Packing (wick)
200374c	14181	Needle Bar Connecting Link Stud Set Screw
200383c	14399	Needle Bar Connecting Link Stud Set Screw
*206891	---	Needle Bar Connecting Stud
202329	11607	" " " " 206891 with 200086c and 202330
202330	---	Needle Bar Connecting Stud Oil Packing (wick)
200086c	11607	Needle Bar Connecting Stud Pinch Screw
202692	14192	Needle Bar Crank with 200335c, 200374c, 200383c, 200428c and 202333
237737	---	Needle Bar Crank 202692 with 202329, 202399, 202400, 202552 and 237762
203172	11607	Needle Bar Crank Friction Washer
200428c	11607	" " " Position Screw ..
200335c	14176	" " " Set Screw
237813	14192	" " Rock Frame
237814	---	" " " " 237813 with 237822
*38127	---	Needle Bar Rock Frame Driving Eccentric
*237749	---	Needle Bar Rock Frame Driving Eccentric Body
350107c	14399	Needle Bar Rock Frame Driving Eccentric Body Position Screw ..
443c	14399	Needle Bar Rock Frame Driving Eccentric Body Set Screw
1103c	14399	Needle Bar Rock Frame Driving Eccentric Regulating Screw
217D	14399	Needle Bar Rock Frame Driving Eccentric Set Screw
7071	14399	Needle Bar Rock Frame Driving Eccentric Set Screw Washer ...

No.	Plate	Name
237750	—	Needle Bar Rock Frame Driving Eccentric complete. Nos. 217b, 443c, 1103c 7071, 38127, 237749 and 350107c
237739	14192	Needle Bar Rock Frame Driving Fork Lever with 200029E
200029E	14399	Needle Bar Rock Frame Driving Fork Lever Pinch Screw
237740	14403	Needle Bar Rock Frame Driving Fork Lever Slide Block (two pieces)
210910	11607	Needle Bar Rock Frame Hinge Stud with 202277
202277	—	Needle Bar Rock Frame Hinge Stud Oil Packing (wick)
200347c	14181	Needle Bar Rock Frame Hinge Stud Set Screw
202667	14192	Needle Bar Rock Frame Rock Shaft
210978	—	“ “ “ “ “ “ 202667 with 200386c and 210920 ..
237815	14198	Needle Bar Rock Frame Position Bracket with 200337c and 201531E
350129E	14198	Needle Bar Rock Frame Position Bracket Screw (2)
202668	11607	Needle Bar Rock Frame Slide Block
210920	—	“ “ “ “ “ “ 202668 with 201141c
201141c	14399	Needle Bar Rock Frame Slide Block Screw Stud
200386c	14415	Needle Bar Rock Frame Slide Block Screw Stud Set Screw
200389c	11610	Needle Set Screw
207072	11607	Presser Bar Bushing (2)
200352c	14198	“ “ “ Set Screw
202671	14399	“ “ Lifter
200653c	14198	“ “ Hinge Screw
207963	14399	“ “ Lifting Releasing Lever Bracket
200975F	14198	Presser Bar Lifting Releasing Lever Bracket Guide Screw
206608	14198	Presser Bar Lifting Releasing Lever Bracket Spring
237820	14198	Presser Bar Position Guide
202338	14198	“ “ “ “ Lever with 200086F
200086F	11607	Presser Bar Position Guide Lever Pinch Screw
200352c	14198	Presser Bar Position Guide Set Screw

No.	Plate	Name
207965	14414	Presser Bar Spring (flat)
210949	14193	“ “ “ Bracket with 200086c
200086c	11607	Presser Bar Spring Bracket Pinch Screw
200538c	14193	Presser Bar Spring Regulating Screw
200948F	14193	Presser Bar Spring Support Screw
201954	—	Roller Presser, $\frac{3}{8}$ in. diam., $\frac{1}{8}$ in. face
201955	14193	Roller Presser 201954 with 1528a, 201699c, 350104c and twenty eight 206417
203422	14193	Roller Presser Arm
237816	—	“ “ “ 203422 with 201955
202560	14193	Roller Presser Arm Bracket (swing)
237817	—	“ “ “ “ “ “ with 200096d and 237816
200675F	14193	Roller Presser Arm Bracket Posi- tion Screw Stud
202558	14193	Roller Presser Arm Bracket Spring
202559	14193	“ “ “ “ “ “ Stop
200141F	11607	Roller Presser Arm Bracket Spring Stop Screw
200096d	14193	Roller Presser Arm Screw
206417	14193	“ “ Ball, $\frac{3}{8}$ in. diameter
201699c	14193	“ “ “ Cone
202557	14192	“ “ Bar
350104c	14193	“ “ Hinge Screw
1528a	14193	“ “ “ “ Nut
237818	—	Roller Presser and Bar complete, Nos. 200675F, 202557 to 202559, 237817 and two 200141F
237762	14193	Take-up Lever
202399	14193	“ “ Driving Stud with 202277
202277	—	Take-up Lever Driving Stud Oil Packing (wick)
202400	14193	Take-up Lever Hinge Stud with 202423
202423	—	Take-up Lever Hinge Stud Oil Packing (wick)
200363c	14193	Take-up Lever Hinge Stud Set Screw
202401	—	Take-up Lever Oiling Felt
200132E	14193	“ “ “ “ Screw ..

No.	Plate	Name
244007	11610	Tension Disc (back)
207964	14415	" " (front)
210950	14193	" Release Driving Lever with 200394c and 202676
202676	14193	Tension Release Driving Lever Pin
237819	14193	" " " " "
		Slide Bar
237828	—	Tension Release Driving Lever Pin Slide Bar 237819 with 200167E and 210952
202678	14193	Tension Release Driving Lever Pin Slide Bar Spring
200394c	14198	Tension Release Driving Lever Set Screw
210951	11610	Tension Release Washer
202407	10881	" Spring
200625F	11610	" Stud with 204925
200061c	14198	" " Set Screw
204925	11610	" " Washer
201572B	10881	" Thumb Nut
210953	11610	Tension complete, Nos. 200625F, 201572B, 202407, 202682, 207964, 210951 and 244007
202682	11610	Thread Controller Spring
210952	11610	" " " Stop
200167E	11610	" " " " Screw
202412	14415	" Guide
210955	11610	" " (upper)
200582H	11610	" " Screw (2)
204329	—	" Oiler (felt)
237776	14415	" " Bracket with 204329 ...
200582H	11610	" " Screw
210956	11610	" Retainer Bracket with 200397H
200582H	11610	" " " Screw (2) ..
202091	14415	" " Sleeve
210993	11610	" " "
202092	14415	" " Spring
223844	14415	" " "
204058	14415	" " Stud
210957	11610	" " "
210958	11610	" " " Collar
200366H	14415	" " " Set Screw
200397H	11610	" " " " "
210959	11610	Thread Retainer (lower) complete, Nos. 210956 to 210958, 210993 and 223844
204059	—	Thread Retainer (upper) complete, Nos. 202091, 202092 and 204058..

No.	Plate	Name
237823	14200	Throat Plate, 53 elongated needle hole, for needle sizes 14 and 15, with 200178D, 200587D, 211416 and 211424, trims opposite the needle and .045 and .085 in. to right of seam
211424	14200	Throat Plate Knife Follower
200587D	14415	" " " " Screw ..
211416	14200	" " " " Spring
200178D	14415	" " " " "
		Screw
6911	14415	Throat Plate Screw (2)
237744	14192	Vertical Shaft
238670	14415	" " Bevel Gear (lower)
205508	14415	" " " " "
		Position Pin
235857	14181	Vertical Shaft Bevel Gear (upper) with 200374c and 200396c
200396c	11607	Vertical Shaft Bevel Gear (upper) Position Screw
200374c	14181	Vertical Shaft Bevel Gear (upper) Set Screw
237734	14181	Vertical Shaft Bushing (lower) ..
200346c	14415	" " " " Set Screw
237746	14192	Vertical Shaft Bushing (upper) ..
200362c	14398	" " " " Set Screw
237747	14415	Vertical Shaft Driving Gear with 200374c and 200396c
200396c	11607	Vertical Shaft Driving Gear Posi- tion Screw
200374c	14181	Vertical Shaft Driving Gear Set Screw
237754	14415	Vertical Shaft Oil Leader (lower) (brass)
237755	14415	Vertical Shaft Oil Leader (upper) (brass)

LIST OF PARTS COMPLETE
FOR
MACHINE No. 110w127

VERTICAL HOOK. ROLLER PRESSER.
 CONTINUOUS WHEEL FEED.
 UNDEREDGE TRIMMER

For Leather Work

No.	Plate	Name
*237801	---	Arm
203091	14196	" Cap
200278H	14176	" " Screw
202248	14176	" " " Washer
203089	14196	" " Spool Holder Base
203090	14196	" " " " " 203089 with 200079H and 204296
200585H	14187	Arm Cap Spool Holder Base Screw
204296	14196	" " " " Wire
200079H	14187	" " " " " Hinge Screw
203092	---	Arm Cap and Spool Holder complete, Nos. 203090, 203091 and two 200585H
204235	14187	Arm Position Pin (2)
200004E	14176	" Screw
200010E	14176	" " (2)
202005	14176	" " Washer (3)
202632	14196	" Side Plate
200462R	14176	" " " Thumb Screw
237802	14414	" Shaft with 200357E and 203100
237748	14196	" " Bushing (back) with 202299
202299	---	Arm Shaft Bushing (back) Oil Packing (wick)
200071E	14176	Arm Shaft Bushing (back) Screw (3)
207080	14196	Arm Shaft Bushing (front) with 202244
202244	---	Arm Shaft Bushing (front) Oil Packing (wick)
200502R	14176	Arm Shaft Bushing (front) Oil Packing Thumb Screw

No.	Plate	Name
200338C	14176	Arm Shaft Bushing (front) Set Screw
203100	---	Arm Shaft Oil Packing (wick)
200357E	14176	" " " " Stop Screw
223842	14414	Balance Wheel (belt groove 2 3/4 diam.) with 200328C and 200335C
200062H	14176	Balance Wheel Adjusting Screw
200328C	14176	" " Position Screw
200335C	14176	" " Set Screw
*237834	---	Bed
237901	14196	" Slide (back)
237959	14196	" " (front)
203470	14176	Bobbin
*203520	---	" Case
203648	14176	" " Latch
*202056	---	" " " Pin
203473	14176	" " " Plunger
203474	14176	" " " Spring
236078	14176	" " Lever
*203476	---	" " " Eccentric
204243	14176	" " " " Position Pin
235751	14176	" " " Fulcrum
200056D	10884	" " " " Screw
203478	14176	" " " Slide Stud
203214	14176	" " Tension Spring
200984C	14176	" " " " Regulat- ing Screw
200594C	14176	Bobbin Case Tension Spring Screw
203216	-	" " Washer (cloth)
203521	14176	Bobbin Case complete, Nos. 200594C, 200984C, 202056, 203214, 203216, 203473, 203474, 203520 and 203648
237804	14414	Face Plate
202135	14176	" " Position Pin
200473B	14176	" " Thumb Screw
237707	14190	Feed Wheel
350085E	14398	" " Adjusting Screw
237708	14398	" " " " Block
238603	14410	" " Bracket with 238630
238604	14410	" " " Plate
200158B	14398	" " " " Screw (2)
237710	14398	" " " Spring
238605	---	" " Driving Gear (for 16 stitches)
238606	---	Feed Wheel Driving Gear (for 18 stitches)
238607	---	Feed Wheel Driving Gear (for 20 stitches)

No.	Plate	Name
238613	14398	Feed Wheel Driving Gear Key
238614	14398	" " " " " Shifting Collar with 201464c
201464c	14187	Feed Wheel Driving Gear Key Shifting Collar Screw Stud
238615	14398	Feed Wheel Driving Gear Key Spring
201202D	14398	Feed Wheel Driving Gear Key Spring Screw
238616	14398	Feed Wheel Driving Gear Key Stop Pin
238617	14398	Feed Wheel Driving Gear Separating Washer
238618	-----	Feed Wheel Driving Pinion (for 16 stitches)
238619	-----	Feed Wheel Driving Pinion (for 18 stitches)
238620	-----	Feed Wheel Driving Pinion (for 20 stitches)
231433	14398	Feed Wheel Driving Pinion Key ..
238632	14403	" " " " Spacing Washer (for use in place of Feed Wheel Driving Pinion when one or two lengths of stitch are required)
238627	14414	Feed Wheel Driving Shaft
237722	14410	" " " " Bushing (back)
238628	14410	Feed Wheel Driving Shaft Bushing (front)
200362c	14398	Feed Wheel Driving Shaft Bushing Set Screw
221743	14398	Feed Wheel Driving Shaft Collar with two 200380c
200380c	14398	Feed Wheel Driving Shaft Collar Set Screw
238669	14414	Feed Wheel Driving Shaft Gear with 200378c and 201220c
201220c	14187	Feed Wheel Driving Shaft Gear Position Screw
200378c	14398	Feed Wheel Driving Shaft Gear Set Screw
201666E	14198	Feed Wheel Driving Shaft Nut ...
203411	14398	" " " " Washer
238629	14398	" " Stud with 238616
238630	14398	" " " Bushing
238631	14391	" " " Collar with 200152n
200152H	14398	" " " " Pinch Screw
201697c	14398	" " " Nut

No.	Plate	Name
*203482	---	Hook (sewing)
203483	14415	" 203482 with 201253E, 201376E and 203251
203547	---	Hook and Bobbin Case complete, Nos. 203483 and 203521
238633	14415	Hook Bevel Gear Socket, 13 teeth..
235527	14181	" " " " Bushing (lower) (brass)
200362c	14398	Hook Bevel Gear Socket Bushing (lower) Set Screw
235756	14181	Hook Bevel Gear Socket Bushing (upper) (brass)
449c	14181	Hook Bevel Gear Socket Bushing (upper) Set Screw
200555H	14181	Hook Bevel Gear Socket Screw ..
235635	14181	" " " " Thrust Washer
235787	14415	Hook Driving Bevel Gear with two 350089c
350089c	14181	Hook Driving Bevel Gear Set Screw
237728	14190	" " " Shaft
235857	14181	" " " Bevel Gear with 200374c and 200396c
237729	14414	Hook Driving Shaft Bevel Gear Housing with 200346c and three 200362c
237730	14410	Hook Driving Shaft Bevel Gear Housing Cap (bottom)
237731	14410	Hook Driving Shaft Bevel Gear Housing Cap (bottom) Gasket ..
237732	14410	Hook Driving Shaft Bevel Gear Housing Cap (side)
237733	14410	Hook Driving Shaft Bevel Gear Housing Cap (side) Gasket
200053c	14181	Hook Driving Shaft Bevel Gear Housing Cap Screw (4)
201082E	14181	Hook Driving Shaft Bevel Gear Housing Screw (long)
225532	14187	Hook Driving Shaft Bevel Gear Housing Screw (long) Washer ..
201308E	14181	Hook Driving Shaft Bevel Gear Housing Screw (short)
200396c	11607	Hook Driving Shaft Bevel Gear Position Screw
200374c	14181	Hook Driving Shaft Bevel Gear Set Screw
237734	14181	Hook Driving Shaft Bushing (back)
200362c	14398	" " " " " Set Screw

No.	Plate	Name
235531	14181	Hook Driving Shaft Bushing (front)
200347c	14181	" " " " " "
		Set Screw
221743	14398	Hook Driving Shaft Collar with two 200380c
200380c	14398	Hook Driving Shaft Collar Set Screw
203251	14415	Hook Gib
201376f	14181	" " Hinge Screw
201253f	14181	" " Screw
237735	14414	" Saddle with 449c, 200347c and three 200362c
235534	14410	Hook Saddle Oil Cover
201185d	14399	" " " " Screw (2) ..
201318E	14399	" " " " Stop Screw (2) ..
235535	---	" " " " Oiling Felt
202260	---	" " " " Wick
235649	14399	" " " " Cover
200169H	14399	" " " " " Screw
201308E	14181	" " " " Screw (2)
203637	---	" " " " Washer (2)
213018	14399	" Washer with 203476 and two 204243
237837	14414	Knee Lifter Connection Lever
200262H	14399	" " " " " Hinge Screw
237766	14190	Knee Lifter Connection Lever Lift- ing Rod with 202302
202302	14399	Knee Lifter Connection Lever Lift- ing Rod Cotter Pin
237838	14414	Knee Lifter Lifting Lever
200262H	14399	" " " " " Hinge Screw
207807	14187	Knife
200368H	14187	" Adjusting Screw
237932	14190	" Bar
237807	14187	" " Angle Extension
200126E	14187	" " " " Screw (2)
221417	14190	" " Driving Eccentric with 200382c and 200437c
202890	14190	Knife Bar Driving Eccentric Fork with 200382c and 201464c
201464c	14187	Knife Bar Driving Eccentric Fork Position Screw
200382c	14198	Knife Bar Driving Eccentric Fork Set Screw
200437c	14187	Knife Bar Driving Eccentric Posi- tion Screw
200382c	14198	Knife Bar Driving Eccentric Set Screw

No.	Plate	Name
202891	14192	Knife Bar Driving Shaft Crank with 200694f and 201525E
203244	14187	Knife Bar Driving Shaft Crank Collar with two 200393c
200393c	14187	Knife Bar Driving Shaft Crank Collar Set Screw
200694f	14187	Knife Bar Driving Shaft Crank Screw Stud
201525E	14187	Knife Bar Driving Shaft Crank Screw Stud Nut
237907	14187	Knife Bar Guide Block
200011d	14187	" " " " Screw (2) ..
200404c	14187	" " " " Screw
201531E	14187	" " " " " Nut
237829	14187	" " " " Lifting Spring
202346	14187	" " " " " Plunger ..
237908	14198	" " " " Position Bracket
201387f	14198	" " " " " Screw (2)
237933	14198	Knife Holder with 200368u
200898d	14198	" " " " Screw
237939	14198	" " " " Switch-in Handle
200076d	14198	" " " " Screw (2)
237812	14192	" " " " Switch-out Handle with two 200403c
200403c	14403	Knife Switch-out Handle Set Screw
202899	14192	" " " " " Shaft
202900	14198	" " " " " Spring (spiral)
237937	14399	Needle Bar with 200141f
202352	11607	" " " " Connecting Link
236073	14399	" " " " " Oil Guard
200161d	11607	Needle Bar Connecting Link Oil Guard Screw
202333	11607	Needle Bar Connecting Link Stud with 202254
202254	---	Needle Bar Connecting Link Stud Oil Packing (wick)
200374c	14181	Needle Bar Connecting Link Stud Set Screw
200383c	14399	Needle Bar Connecting Link Stud Set Screw
*206891	---	Needle Bar Connecting Stud
202329	11607	" " " " " 206891 with 200086c and 202330
202330	---	Needle Bar Connecting Stud Oil Packing (wick)
200086c	11607	Needle Bar Connecting Stud Pinch Screw

No.	Plate	Name
202692	14192	Needle Bar Crank with 200335c, 200374c, 200383c, 200428c and 202333
237737	—	Needle Bar Crank 202692 with 202329, 202399, 202400, 202552 and 237762
203172	11607	Needle Bar Crank Friction Washer
200428c	11607	" " " Position Screw ..
200335c	14176	" " " Set Screw
237813	14192	" " " Rock Frame
237931	—	" " " " 237813 with 237937
*38127	—	Needle Bar Rock Frame Driving Eccentric
*237749	—	Needle Bar Rock Frame Driving Eccentric Body
350107c	14399	Needle Bar Rock Frame Driving Eccentric Body Position Screw ..
443c	14399	Needle Bar Rock Frame Driving Eccentric Body Set Screw
1103c	14399	Needle Bar Rock Frame Driving Eccentric Regulating Screw
217d	14399	Needle Bar Rock Frame Driving Eccentric Set Screw
7071	14399	Needle Bar Rock Frame Driving Eccentric Set Screw Washer ..
237750	—	Needle Bar Rock Frame Driving Eccentric complete, Nos. 217d, 443c, 1103c, 7071, 38127, 237749 and 350107c
237739	14192	Needle Bar Rock Frame Driving Fork Lever with 200029f
200029f	14399	Needle Bar Rock Frame Driving Fork Lever Pinch Screw
237740	14403	Needle Bar Rock Frame Driving Fork Lever Slide Block (two pieces)
210910	11607	Needle Bar Rock Frame Hinge Stud with 202277
202277	—	Needle Bar Rock Frame Hinge Stud Oil Packing (wick)
200347c	14181	Needle Bar Rock Frame Hinge Stud Set Screw
202667	14192	Needle Bar Rock Frame Rock Shaft
210978	—	" " " " " " " " 202667 with 200386c and 210920 ..
237910	14198	Needle Bar Rock Frame Position Bracket with 200404c and 201531E
350129E	14198	Needle Bar Rock Frame Position Bracket Screw (2)

No.	Plate	Name
202668	11607	Needle Bar Rock Frame Slide Block
210920	—	" " " " " " " " 202668 with 201141c
201141c	14399	Needle Bar Rock Frame Slide Block Screw Stud
200386c	14415	Needle Bar Rock Frame Slide Block Screw Stud Set Screw
200141f	11607	Needle Set Screw
207072	11607	Presser Bar Bushing (2)
200352c	14198	" " " " Set Screw (2) ..
202671	14399	" " " Lifter
200653c	14198	" " " Hinge Screw
207963	14399	" " " Lifting Releasing Lever Bracket
200975f	14198	Presser Bar Lifting Releasing Lever Bracket Guide Screw
206608	14198	Presser Bar Lifting Releasing Lever Bracket Spring
237820	14198	Presser Bar Position Guide
202338	14198	" " " " " Lever with 200086f
200086f	11607	Presser Bar Position Guide Lever Pinch Screw
200352c	14198	Presser Bar Position Guide Set Screw
207965	14414	Presser Bar Spring (flat)
210949	14193	" " " " Bracket with 200086c
200086c	11607	Presser Bar Spring Bracket Pinch Screw
200538c	14193	Presser Bar Spring Regulating Screw
200948f	14193	Presser Bar Spring Support Screw
201954	—	Roller Presser, $\frac{3}{8}$ in. diam., $\frac{1}{2}$ in. face
201955	14193	Roller Presser 201954 with 1528a, 201699c, 350104c and twenty-eight 206417
203422	14193	Roller Presser Arm
237816	—	" " " " 203422 with 201955
202560	14193	Roller Presser Arm Bracket (swing)
237817	—	" " " " " 202560 with 200096b and 237816
200675f	14193	Roller Presser Arm Bracket Position Screw Stud
202558	14193	Roller Presser Arm Bracket Spring
202559	14193	" " " " " " " " Stop

No.	Plate	Name
225459	10884	Stop Latch Thumb Lever Hinge Stud
225459	10884	Stop Latch Thumb Lever Joint Stud
202478	10884	" " Trip Lever
200299H	10884	" " " " Hinge Screw
225461	10881	Tension Bracket with 201499B
200082D	10881	" " Screw
228026	10884	" " Washer
2102	10881	" Disc
202407	10881	" Spring
201499B	10881	" Stud
201572B	10881	" " Thumb Nut
225462	10881	Bobbin Winder Tension Bracket complete, Nos. 201572B, 202407, 225461 and two 2102
225433	10885	Bobbin Winder and Tension Bracket Base
225382	10885	Universal Bobbin Winder complete, Nos. 200056E, 200082D, 200299H, 202473, 202478, 225381, 225433, 225444, 225453 to 225456, 225458, 225462, 228026, two each 225459 and wood screws $\frac{3}{4}$ in., No. 12, R.H.B.

KNEE LIFTER

2763	14407	Rock Shaft
7539	14407	" " Hanger (back) with two wood screws 1 in., No. 10 ..
20093	14407	Rock Shaft Hanger (front) with two wood screws 1 in., No. 10 ..
228562	14407	Rock Shaft Knee Arm
228563	—	Rock Shaft Knee Arm complete, Nos. 1507R, 2766, 2767 and 228562
2766	14407	Rock Shaft Knee Arm Hub with 356c
356c	14407	Rock Shaft Knee Arm Hub Set Screw
1507R	14407	Rock Shaft Knee Arm Lock Nut ..
2767	14407	" " " Plate with 356c ..
228255	14407	" " " " Counter-balance Spring
356c	14407	Rock Shaft Knee Plate Set Screw
228238	14407	" " Lifting Lever with 356c
228239	—	" " " " 228238 with 8073, 204225, 228240 and 228241 ..
228240	14407	Rock Shaft Lifting Lever Rod (3 in. long)

No.	Plate	Name
200529c	14407	Rock Shaft Lifting Lever Rod Set Screw
228241	14407	Rock Shaft Lifting Lever Rod Swivel with 200529c
204225	14407	Rock Shaft Lifting Lever Rod Swivel Spring
8073	14407	Rock Shaft Lifting Lever Rod Swivel Spring Plunger
356c	14407	Rock Shaft Lifting Lever Set Screw
2770	14407	" " Stop Dog with 356c ...
356c	14407	" " " " Set Screw ..
228243	14407	Rock Shaft complete, Nos. 2763, 7539, 20093, 228239, 228255, 228563, Form A 1079 and two 2770

(Other Knee Lifter parts are listed with parts of machine head.)

FEED GEARS

238641	—	Feed Wheel Driving Gear (for 12 stitches)
238642	—	Feed Wheel Driving Gear (for 14 stitches)
238643	—	Feed Wheel Driving Gear (for 15 stitches)
238605	—	Feed Wheel Driving Gear (for 16 stitches)
238606	—	Feed Wheel Driving Gear (for 18 stitches)
238607	—	Feed Wheel Driving Gear (for 20 stitches)
238608	—	Feed Wheel Driving Gear (for 21 stitches)
238609	14403	Feed Wheel Driving Gear (for 22 stitches)
238610	—	Feed Wheel Driving Gear (for 24 stitches)
238611	—	Feed Wheel Driving Gear (for 25 stitches)
238651	—	Feed Wheel Driving Gear (for 27 stitches)
238612	—	Feed Wheel Driving Gear (for 29 stitches)
238653	—	Feed Wheel Driving Gear (for 31 stitches)
238654	—	Feed Wheel Driving Gear (for 33 stitches)

No.	Plate	Name
238655	—	Feed Wheel Driving Pinion (for 12 stitches)
238656	—	Feed Wheel Driving Pinion (for 14 stitches)
238657	—	Feed Wheel Driving Pinion (for 15 stitches)
238618	—	Feed Wheel Driving Pinion (for 16 stitches)
238619	—	Feed Wheel Driving Pinion (for 18 stitches)
238620	—	Feed Wheel Driving Pinion (for 20 stitches)
238621	—	Feed Wheel Driving Pinion (for 21 stitches)
238622	14403	Feed Wheel Driving Pinion (for 22 stitches)
238623	—	Feed Wheel Driving Pinion (for 24 stitches)
238624	—	Feed Wheel Driving Pinion (for 25 stitches)
238665	—	Feed Wheel Driving Pinion (for 27 stitches)
238625	—	Feed Wheel Driving Pinion (for 29 stitches)
238667	—	Feed Wheel Driving Pinion (for 31 stitches)
238668	—	Feed Wheel Driving Pinion (for 33 stitches)

FEED WHEELS

237707	14190	Feed Wheel
237767	14382	" " (coarse)
237771	14382	" " (knurled)
238523	14382	" "

GUIDES

FOR MACHINE No. 110w127

237902	14188	Guide Bed with 26550
200397H	11610	" " Adjusting Screw
237938	14188	" Finger to trim back of needle
26756	14188	" " " " opposite the needle

No.	Plate	Name
26543	—	Guide Finger Carrier
1073J	14188	" " " " Regulating Thumb Screw
1550J	14188	Guide Finger Carrier Regulating Thumb Screw Nut
50009J	14188	Guide Finger Carrier Screw
35777	14188	" " " " Friction Plate
26544	14188	Guide Finger Carrier complete, Nos. 1075E, 26543, 26546 and three 2523
26546	—	Guide Finger Position Plate
2523	14188	" " " " Rivet ..
219J	14188	" " Screw
1075E	14415	" Regulating Screw Stud
1536J	14188	" " Thumb Nut
200907B	14188	" Screw
26547	14188	" Slide
26548	14188	" " Latch
26549	14188	" " " Cap with 2081 ...
50169J	14188	" " " " Screw
2975	14188	" " " Spring
2081	14188	" " " Stop Pin
26550	—	" " " Stud
26551	14188	" " Spring
1074E	14188	" " Stop Stud
237903	14188	" Swing Base with two 200397H
200246B	14187	" " " Hinge Screw ...
201525E	14187	" " " " " Nut
225708	14187	" " " Spring
237905	14190	Guide (adjustable), for trimming back of needle, complete, Nos. 219J, 1073J, 1074E, 1536J, 1550J, 2975, 26544, 26547 to 26549, 26551, 35777, 50009J, 200246B, 201525E, 225708, 237902, 237903, 237938, two each 50169J and 200907B ...
237904	—	Guide (adjustable), for trimming opposite the needle, complete, Nos. 219J, 1073J, 1074E, 1536J, 1550J, 2975, 26544, 26547 to 26549, 26551, 26756, 35777, 50009J, 200246B, 201525E, 225708, 237902, 237903, two each 50169J and 200907B

THROAT PLATES

FOR MACHINE No. 110w126

No.	Plate	Name
(237823) 237863	14200	Throat Plate, 53 elongated needle hole, for needle sizes 14 and 15, with 200178D, 200587D, 211416 and 211426, trims opposite the needle and .045 and .085 in. to right of seam

FOR MACHINE No. 110w127

237940	—	Throat Plate Body, for trimming opposite the needle and .040 and .050 in. to right of seam, for 237946 and 237947
237941	—	Throat Plate Body, for trimming opposite the needle and .060 and .075 in. to right of seam, for 237948 and 237949
237950	—	Throat Plate Body, for trimming back on needle and .015 and .025 in. to right of seam, for 237956 and 237957
237951	—	Throat Plate Body, for trimming back of needle and .040 and .050 in. to right of seam, for 237958 ..
237942	14200	Throat Plate Knife Cutting Bar, 56 elongated needle hole, for needle sizes 12 and 13, trims opposite the needle and .040 in. to right of seam, for 237946
237943	—	Throat Plate Knife Cutting Bar, 56 elongated needle hole, for needle sizes 12 and 13, trims opposite the needle and .050 in. to right of seam, for 237947
237944	—	Throat Plate Knife Cutting Bar, 56 elongated needle hole, for needle sizes 12 and 13, trims opposite the needle and .060 in. to right of seam, for 237948

No.	Plate	Name
237945	—	Throat Plate Knife Cutting Bar, 56 elongated needle hole, for needle sizes 12 and 13, trims opposite the needle and .075 in. to right of seam, for 237949
237952	—	Throat Plate Knife Cutting Bar, 56 elongated needle hole, for needle sizes 12 and 13, trims back of needle and .015 in. to right of seam, for 237956
237953	—	Throat Plate Knife Cutting Bar, 56 elongated needle hole, for needle sizes 12 and 13, trims back of needle and .025 in. to right of seam, for 237957
237954	14200	Throat Plate Knife Cutting Bar, 56 elongated needle hole, for needle sizes 12 and 13, trims back of needle and .040 in. to right of seam, for 237958
237946	14200	Throat Plate complete, 56 elongated needle hole, for needle sizes 12 and 13, trims opposite the needle and .040 in. to right of seam, Nos. 237940, 237942 and two 200583π..
237947	—	Throat Plate complete, 56 elongated needle hole, for needle sizes 12 and 13, trims opposite the needle and .050 in. to right of seam, Nos. 237940, 237943 and two 200583π ..
237948	—	Throat Plate complete, 56 elongated needle hole, for needle sizes 12 and 13, trims opposite the needle and .060 in. to right of seam, Nos. 237941, 237944 and two 200583π..
237949	—	Throat Plate complete, 56 elongated needle hole, for needle sizes 12 and 13, trims opposite the needle and .075 in. to right of seam, Nos. 237941, 237945 and two 200583π..
237956	—	Throat Plate complete, 56 elongated needle hole, for needle sizes 12 and 13, trims back of needle and .015 in. to right of seam, Nos. 237950, 237952 and two 200583π..
237957	—	Throat Plate complete, 56 elongated needle hole, for needle sizes 12 and 13, trims back of needle and .025 in. to right of seam, Nos. 237950, 237953 and two 200583π..

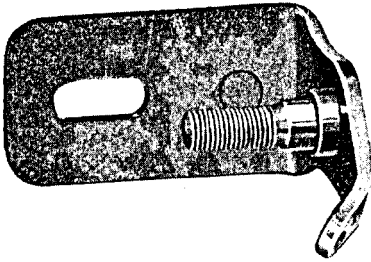
No.	Plate	Name
237958	14200	Throat Plate complete, 56 elongated needle hole, for needle sizes 12 and 13, trims back of needle and .040 in. to right of seam, Nos. 237951, 237954 and two 200583H..

OBSOLETE PARTS

235755	14181	Hook Bevel Gear Socket, 18 teeth
235529	14181	" Driving Bevel Gear with two 350089c

PLATE 10881—FULL SIZE

225461



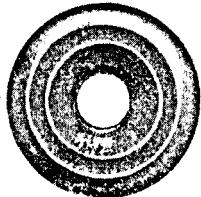
200082



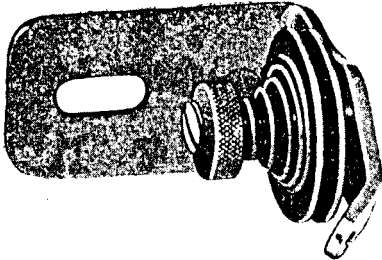
202104



2102



225462



202407



201499

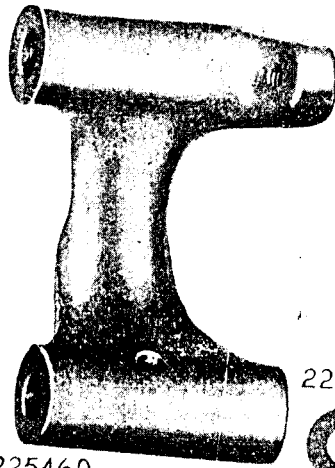


201572

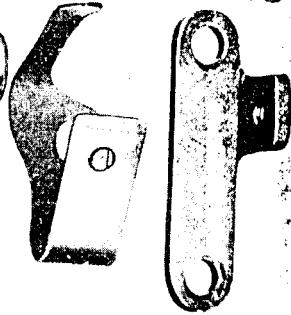


PLATE 10884—FULL SIZE

225453

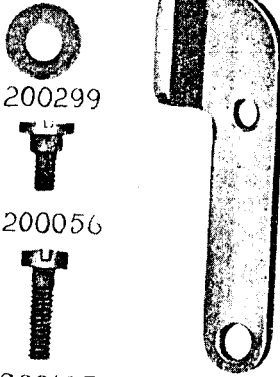


225444 202478



228026

225458



225460

225454

200299



225438

200056



225459

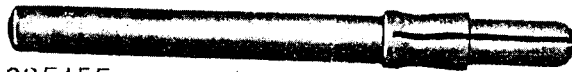
200105



225456



225381



225455



PLATE 10885—ONE-FOURTH SIZE

225433



202473



225382



PLATE 11607 - FULL SIZE

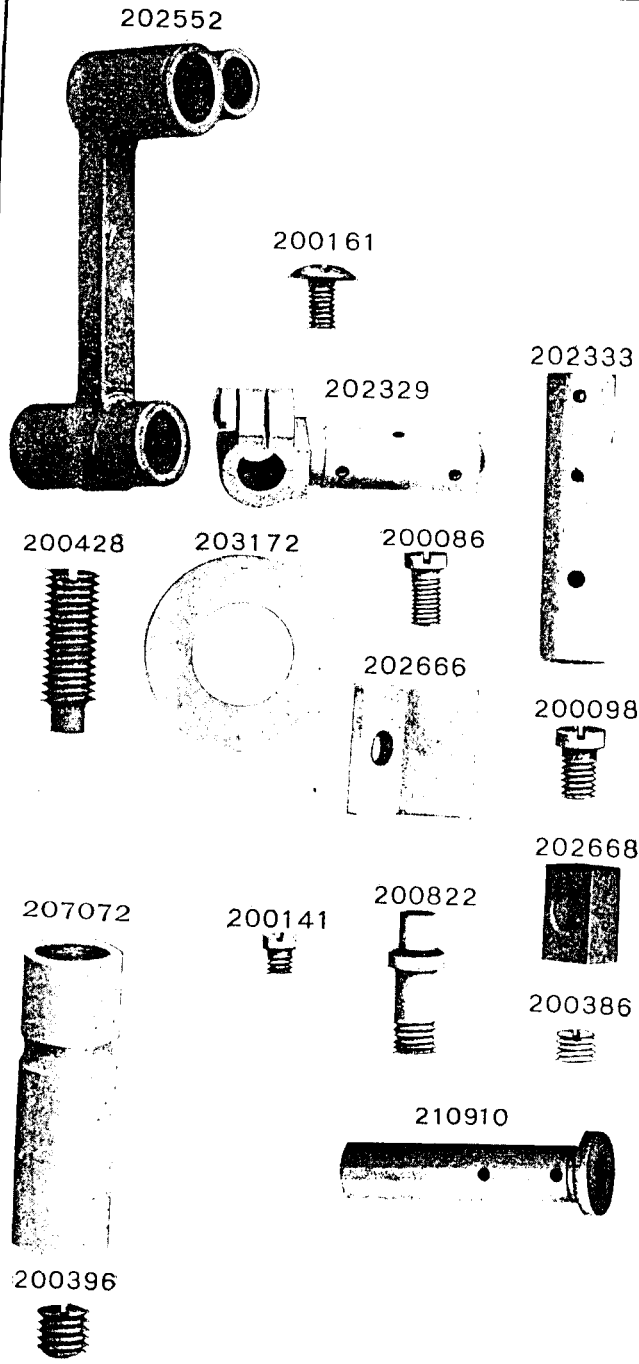


PLATE 11610 - FULL SIZE

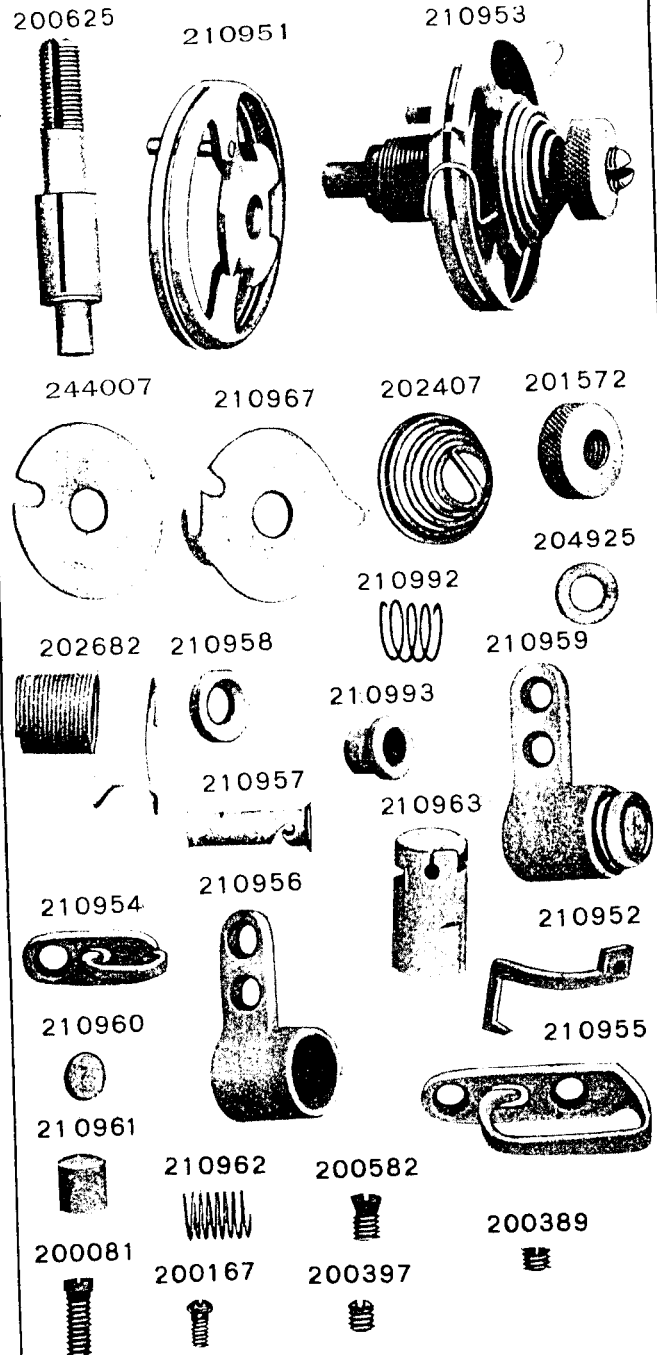


PLATE 14176—FULL SIZE

200278 202248 200071 202036 200338

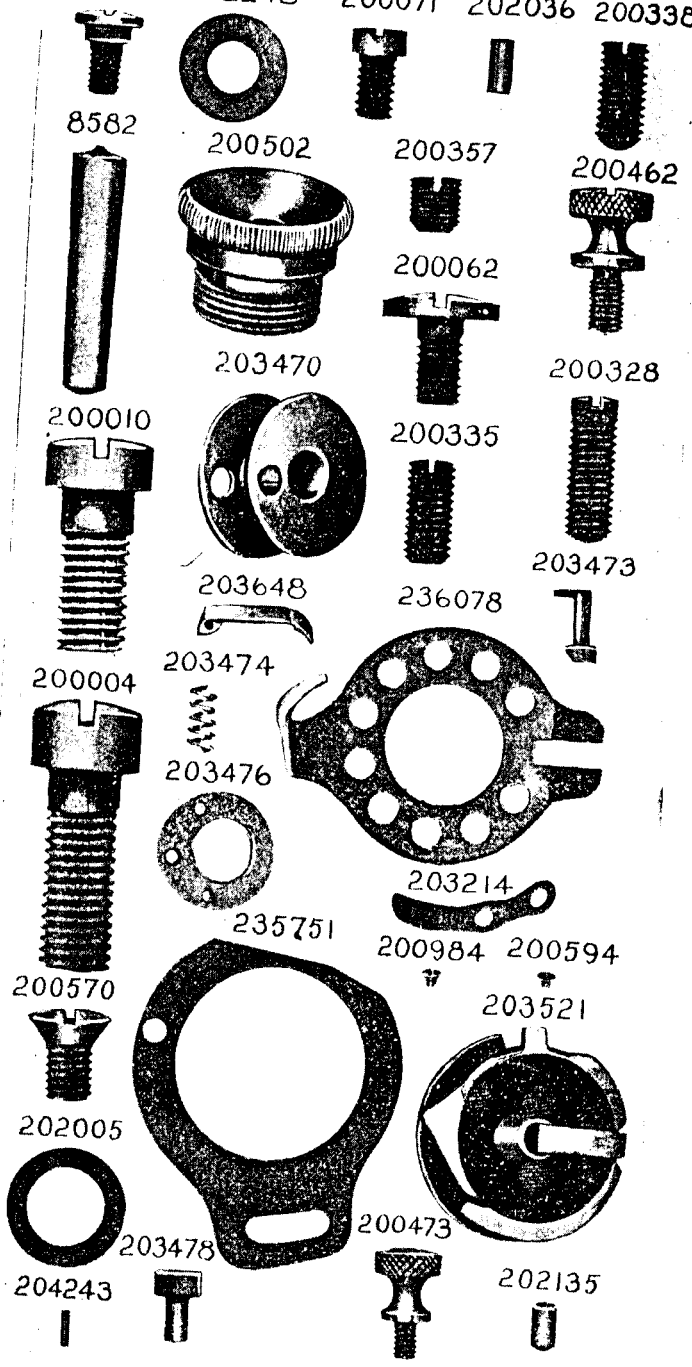
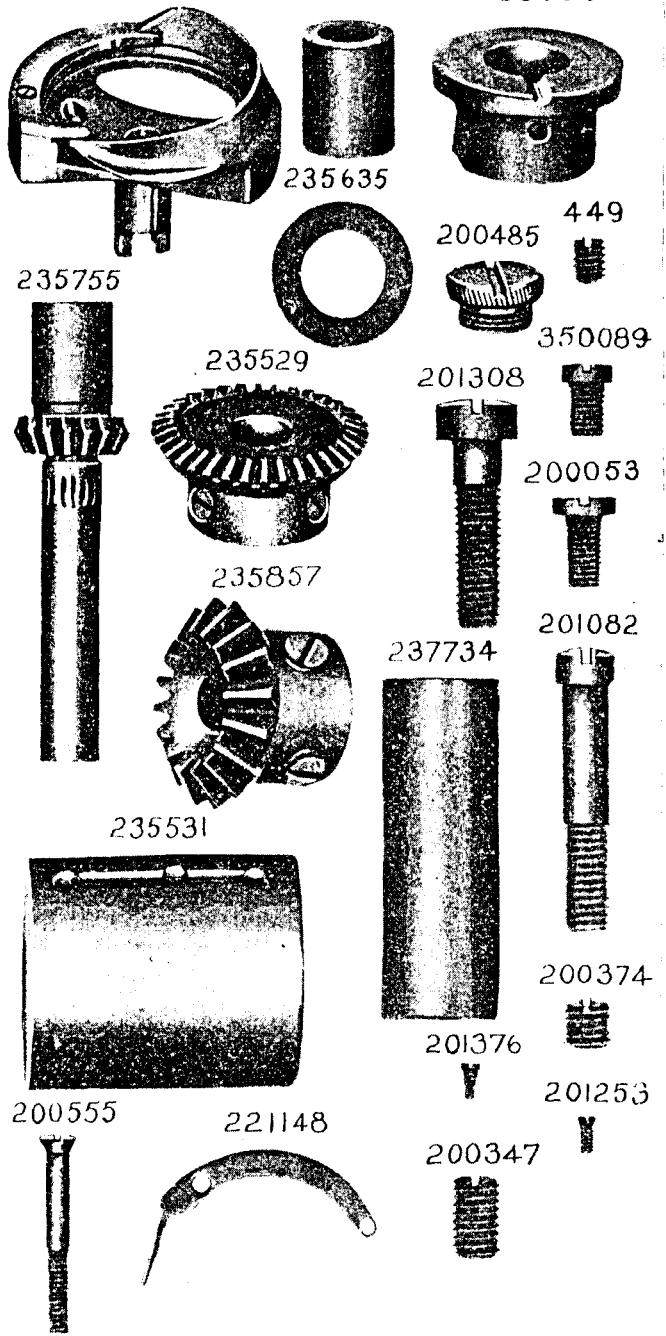


PLATE 14181—FULL SIZE

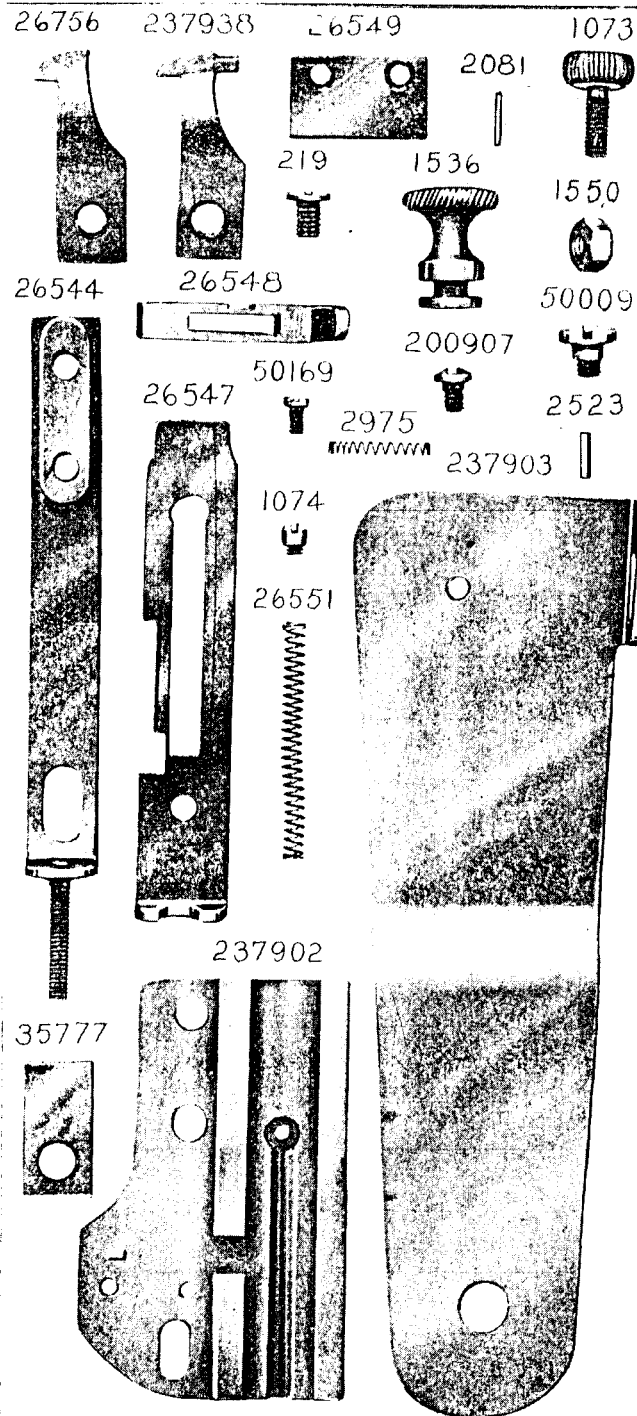
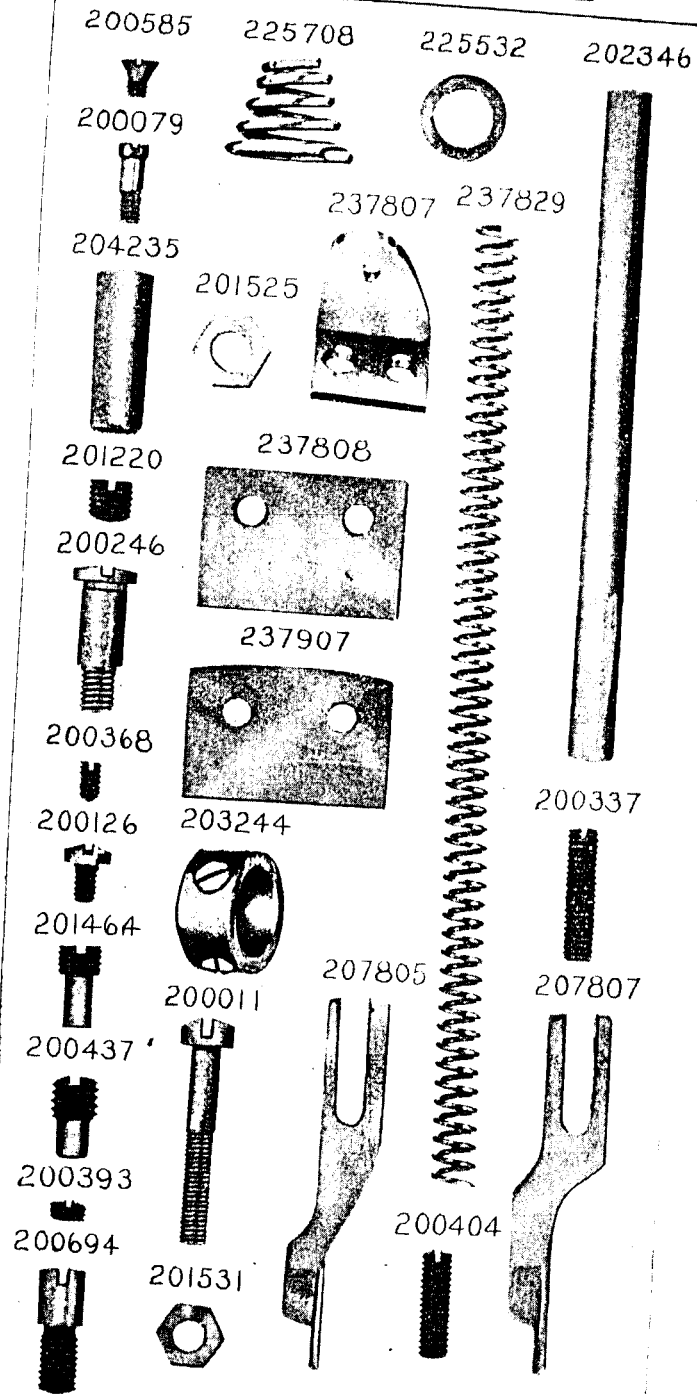
237726 235527 235756



From the library of: Diamond Needle Corp

PLATE 14187—FULL SIZE

PLATE 14188—FULL SIZE



From the library of: Diamond Needle Corp

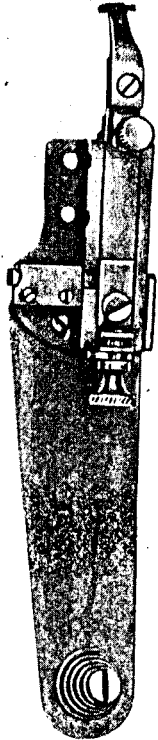
PLATE 14190—ONE-HALF SIZE

237707
237767 237728

237766



237905



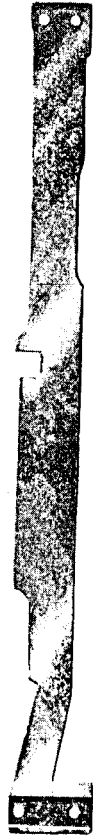
221417



237806



237932



208490



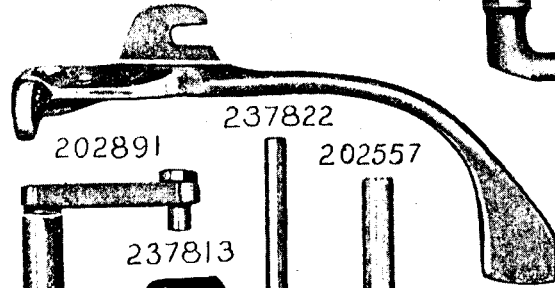
202890



PLATE 14192—ONE-HALF SIZE

237812

202667

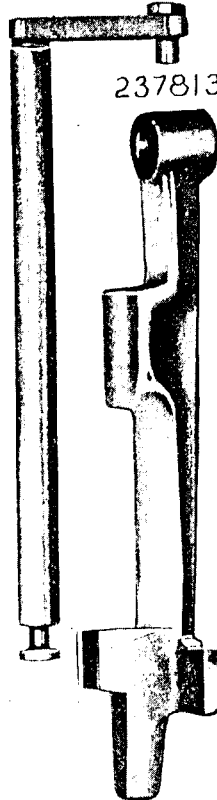


202891

237822

202557

237813



237744

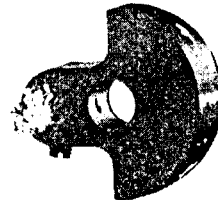
202899



237746



202692



237739

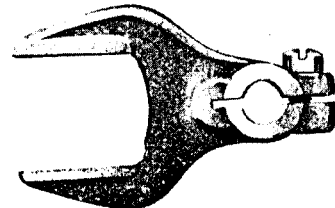


PLATE 14193—FULL SIZE

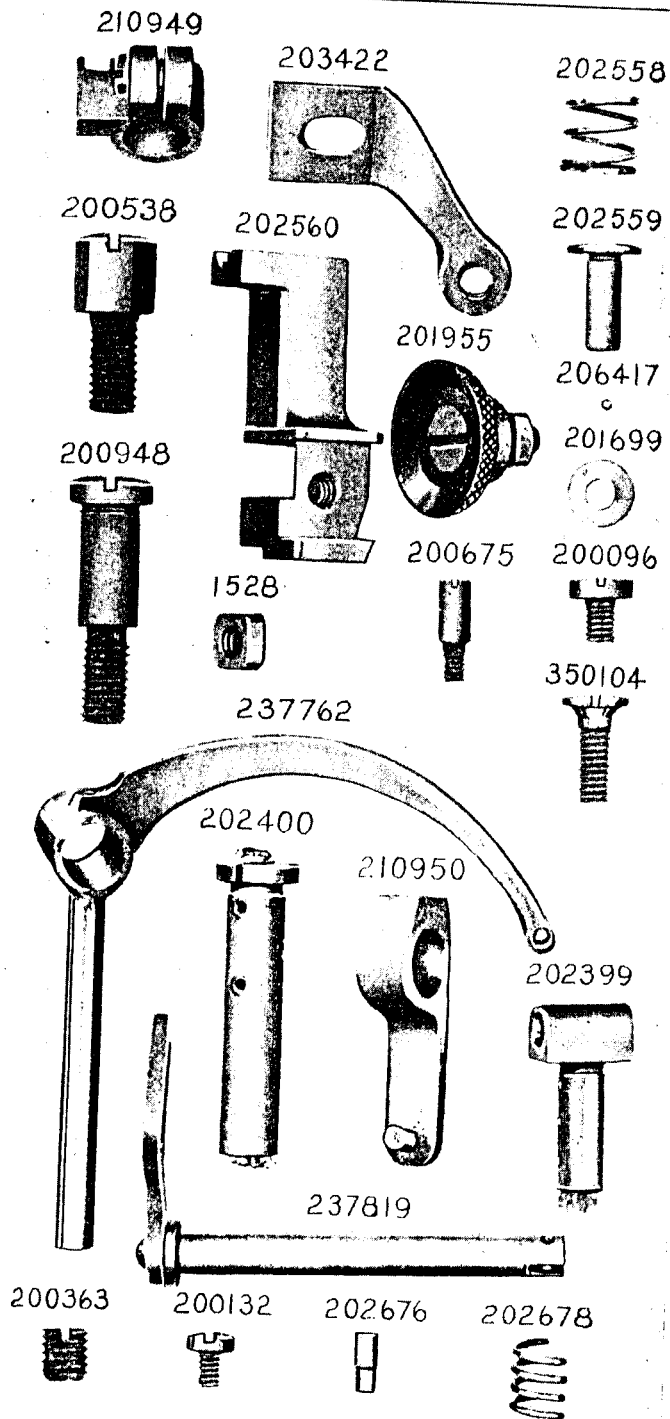


PLATE 14196—ONE-HALF SIZE

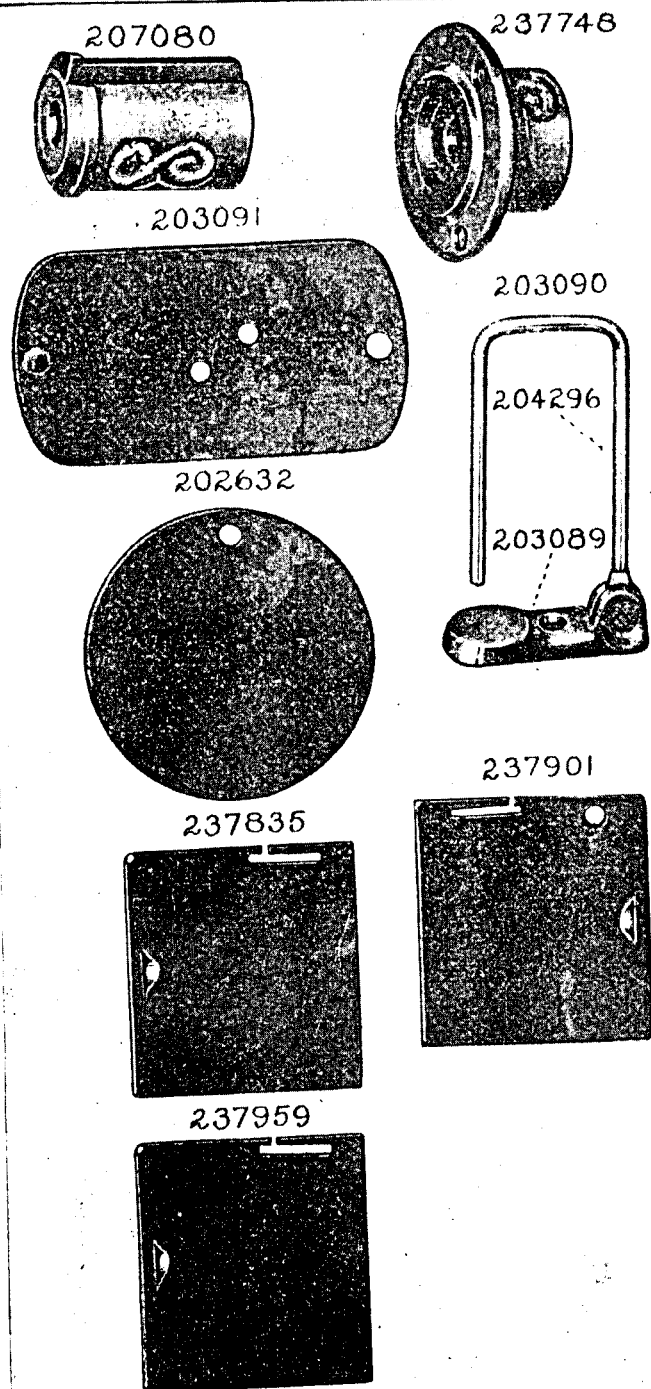


PLATE 14198—FULL SIZE

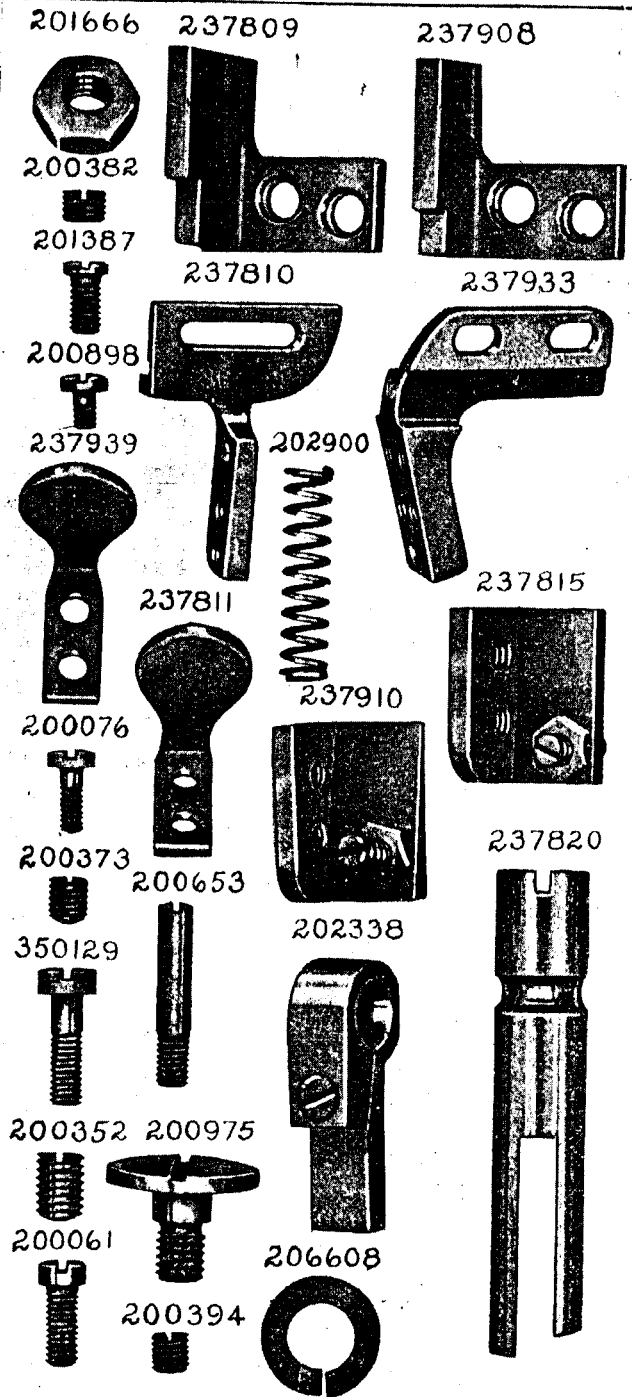


PLATE 14200—FULL SIZE

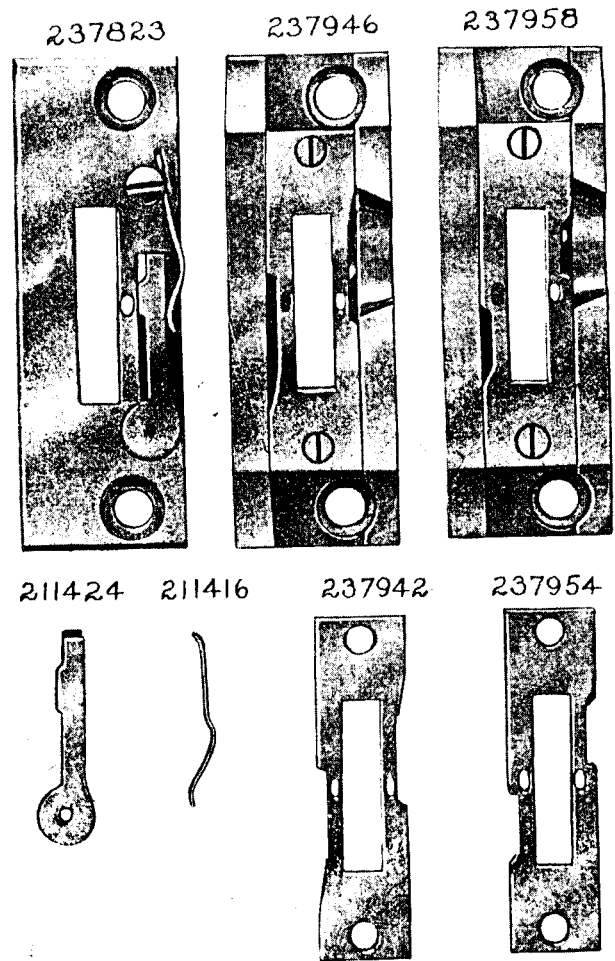
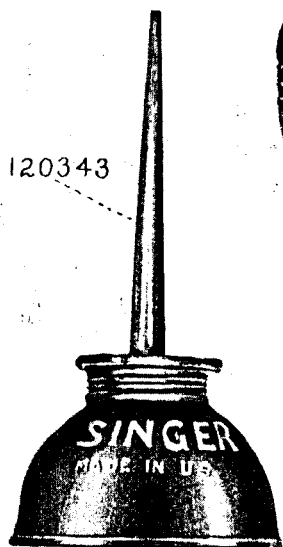


PLATE 14334—ONE-HALF SIZE

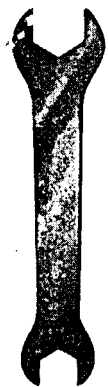
120342

225498

225497



225554



12361

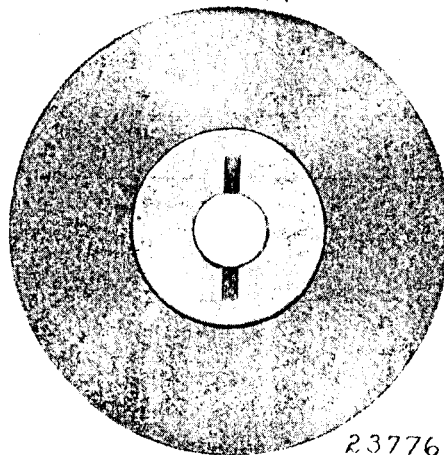


41400

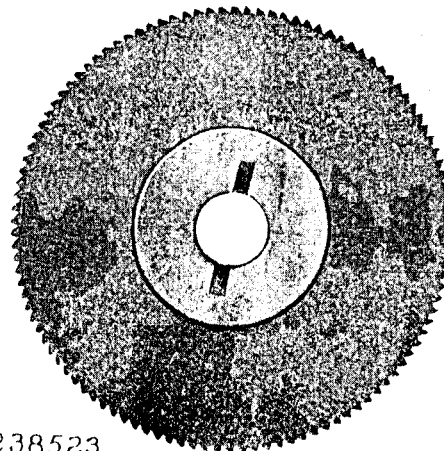


PLATE 14382—FULL SIZE

237771



237767



238523

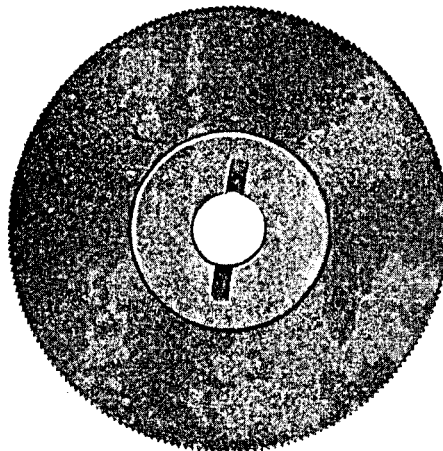


PLATE 14403—FULL SIZE

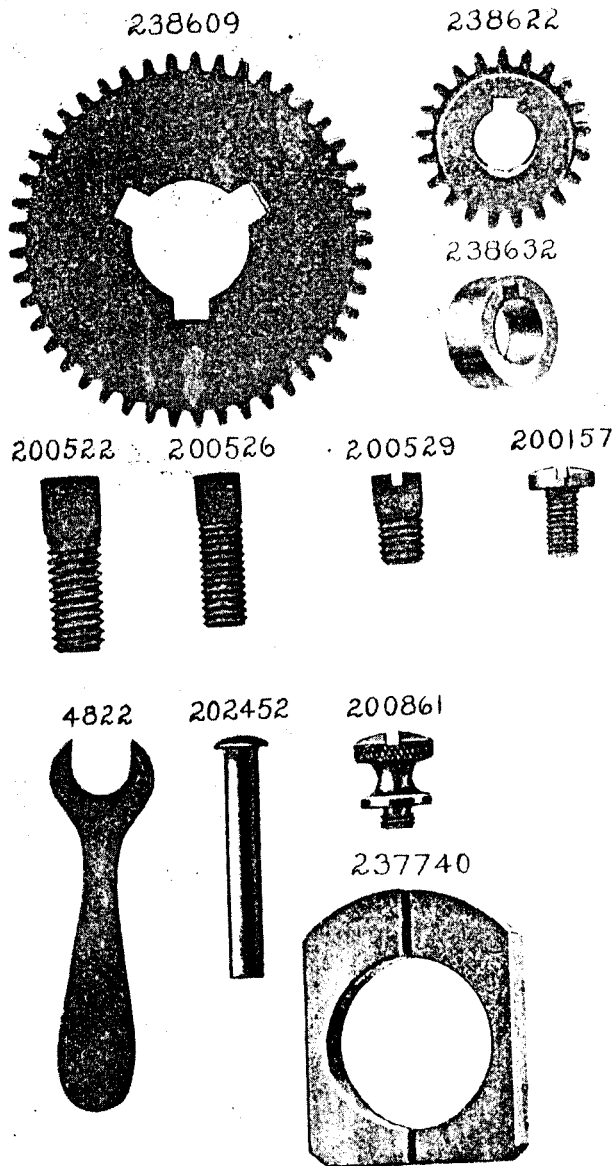
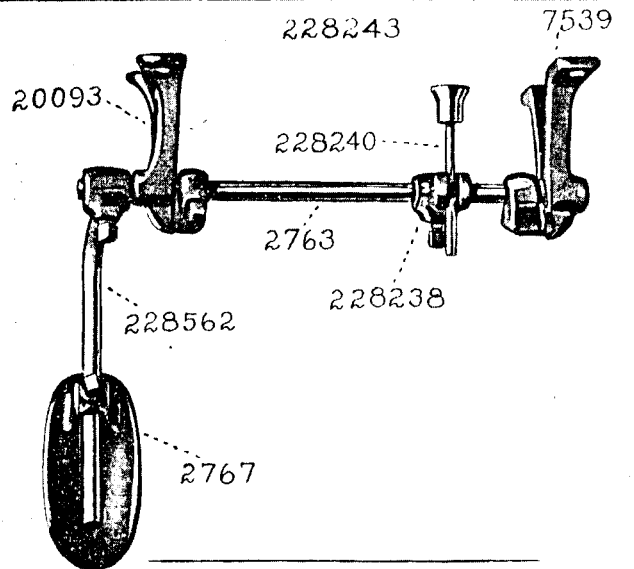


PLATE 14407—ONE-FOURTH SIZE



FULL SIZE

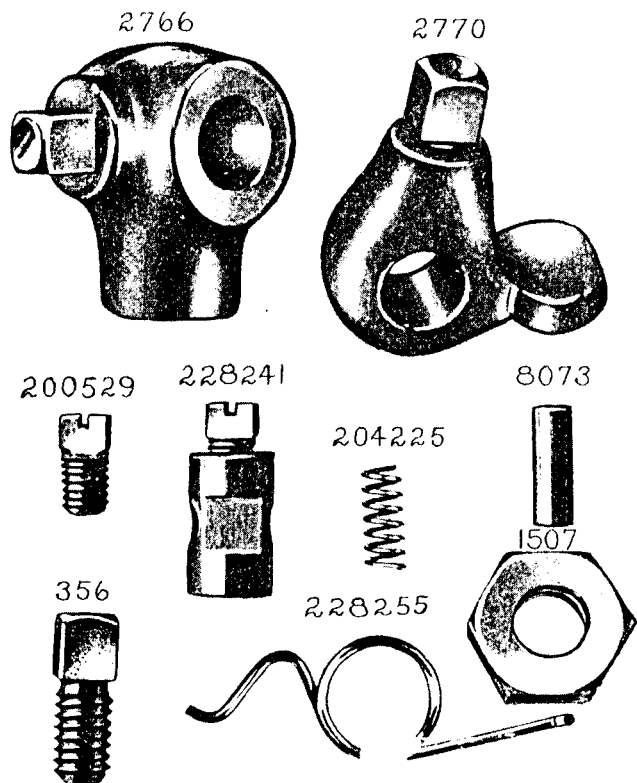
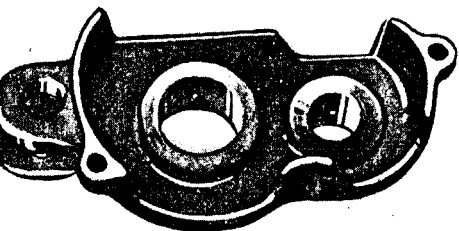


PLATE 14410—ONE-HALF SIZE

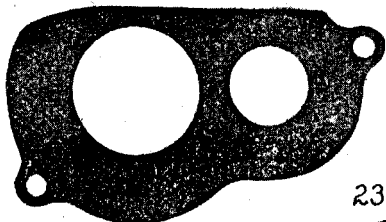
238603



237722



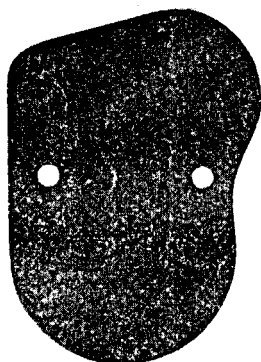
238604



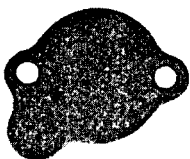
238628



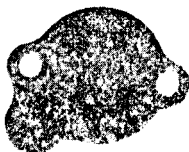
237732



237730

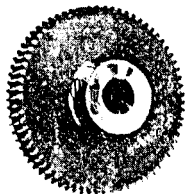
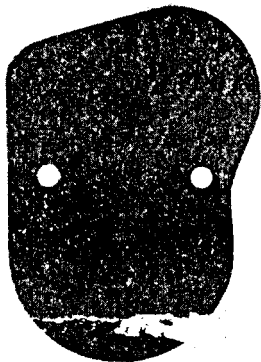


237731



238669

237733



235534

